



# Installation Instructions

## Reversing Camera/Monitor System

### Introduction:

Code 3's Reversing Camera System is designed to provide visual cues to help drivers avoid collisions when backing up. A driver using a properly installed and maintained rear view system can be alerted to potential safety hazards and thus take the appropriate action to prevent an accident. This manual provides information about installation, function, safety, maintenance, replacement parts, and warranty.



### WARNING!

Failure to install or use this product according to manufacturers recommendations may result in property damage, serious bodily/personal injury, and/or death to you and those you are seeking to protect!



**Do not install and/or operate this safety product unless you have read and understand the safety information contained in this manual.**

1. Proper installation combined with operator training in the use, care, and maintenance of vehicle camera systems are essential to ensure the safety of you and those you are trying to protect.
2. Exercise caution when working with live electrical connections.
3. This product must be properly grounded. Inadequate grounding and/or shorting of electrical connections can cause high current arcing, which can cause personal injury and/or severe vehicle damage, including fire.
4. Proper placement and installation are vital to the performance of this device. Install this product so that output performance of the system is maximized and the controls are placed within convenient reach of the operator so that s/he can operate the system without losing eye contact with the roadway.
5. It is the responsibility of the vehicle operator to ensure during use that all features of this product work correctly. In use, the vehicle operator should ensure the projection of the signal is not blocked by vehicle components (i.e., open trunks or compartment doors), people, vehicles, or other obstructions.



### WARNING!

1. High voltage is present within the monitor. The opening of the case should be by professionals.
2. Do not watch the video while driving unless you are monitoring the rear view camera display.

**IMPORTANT!** Occasionally, a few highlights or dark spots may occur on the LCD screen. This is a very common phenomenon in active matrix display technology, and doesn't necessarily indicate any defects or faults. Never try to repair this device by yourself. In case of any problems, please turn off the display at once and notify our company or authorized dealer. The monitor is a complex device. Any disassembly or modification may lead to damage and void the warranty.

CAMERA	CC2015-C - Flush Mount
Image	Color CMOS NTSC: 580*540 PAL: 580*492
Voltage Requirement	12V +/-1V
Power Consumption	< 1w
Lens	N/A
Lens Angle	120°
Audio	No audio function
Light Sensor	CMOS
Infrared LEDs	10
Pigtail Connection: CAM	Female 4 Pin Threaded
Housing	Aluminum alloy
Mech. Vibration	SAE J575
Mounting	Flush mount
Weight	0.74 lbs (0.3kg)
Dimensions (WxHxD)	1.69 x 1.24 x 1.10 in 43 x 31.5 x 28 mm
Operating Temp.	-22°F to 158°F
IP Rating	IP69K
Approvals	CE, FCC, RoHS
Current Consumption	0.43A

MONITOR	CC4204-M - 4.3" RV Mirror
Image	4.3" LCD Color, 4:3
Controller	Internal/2 camera
Voltage	12-24V
Power Consumption	3W
Mirror Imaging	Yes (via menu of mirror)
Split Screen Feature	No
AV Compatible	No
Audio	No
Contrast/Brightness	Yes
Light Sensor	N/A
Camera Selection	1-2 Trigger Wires
Connection: CAM	Female 4 Pin Threaded
Connection (Mirror Pigtail)	Male 8 Pin
Connection: CB	N/A
Housing	Plastic
Mounting	Pedestal Bracket
Mech. Vibration	2.84 g
Weight	1.1 lbs
Dimensions (WxHxD)	11.04 x 1.20 x 3.60 in 280.33 x 30.5 x 91.52 mm
Operating Temp	-4°F to 158°F
Remote Control	Yes
Approvals	CE, FCC, RoHS



## WARNING!

To prevent accidental shock, **DO NOT OPEN THE MONITOR CASE.** Opening the monitor case will expose the inside of the monitor to conditions that could adversely affect performance. Any evidence of tampering with sealed components will void the warranty.

## Wiring:

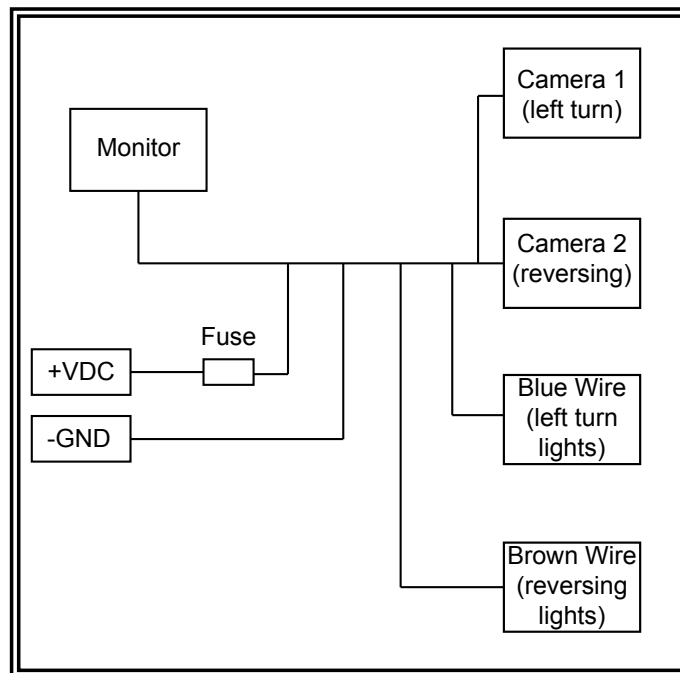

**Accessories:**

- 1. AV and power supply cable.
- 2. Center mount bracket.

**Parts Identification:**

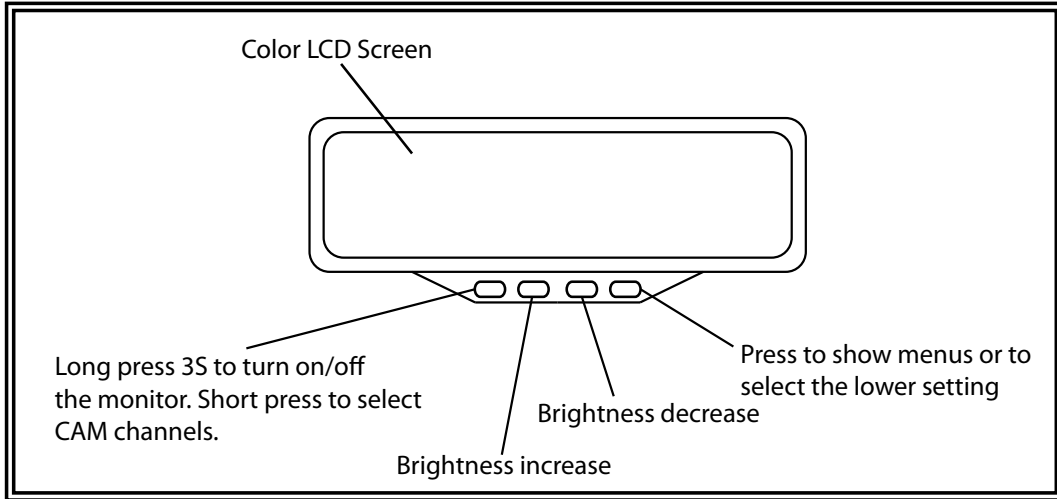

**Basic Operation:**

Connection Diagram

- Black 4 pin male for Camera 1/ Camera 2.
- Single red wire to positive power supply of DC/12-32V.
- Single black wire to GND.
- Single brown wire to positive power wire of back-up light.
- Single blue wire to positive power wire of left light.

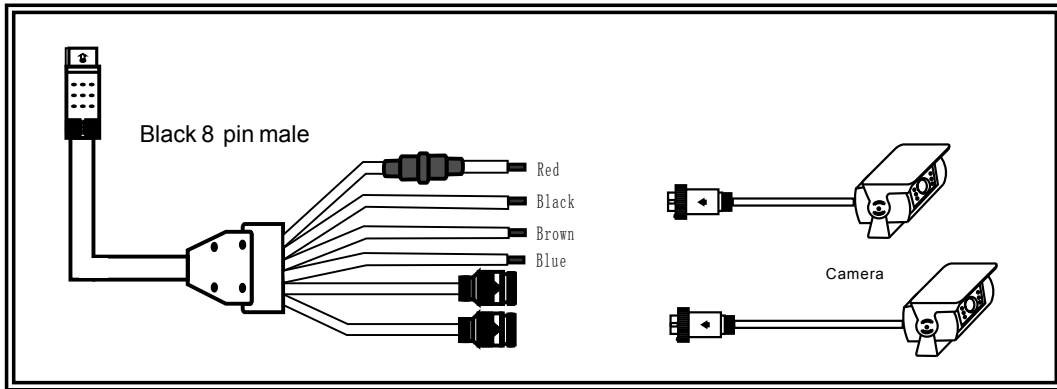

Reversing Display:

1. When the blue wire is connected to the positive wire of the left turn light, the monitor will automatically switch to CAM 1 (left side camera) when the left turn indicator is activated.

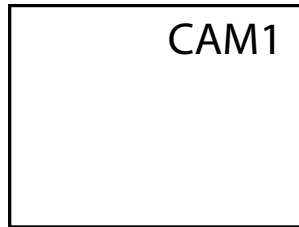

2. When the brown wire is connected to the positive wire of the back-up light, the monitor will automatically switch to CAM 2 (back-up camera). The distancing grid will also be displayed.

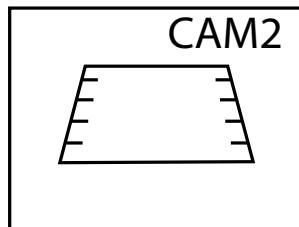

**Menu:**

Press MENU to display the following options and settings:

1. Picture
2. Option

1. Picture: BRIGHT, CONTRAST, COLOR, AUTO DIM and SCALE ADJUST options will display on the screen as illustrated below:

- Press M to select BRIGHT

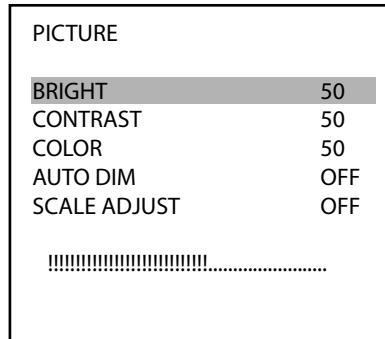

Press  to adjust the brightness level.

- When auto dim is turned on in dark environment, OSD turns into dim mode for dim setting. When auto dim is turned on / off in bright environment, OSD displays normal mode.

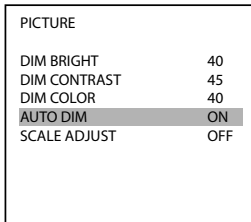

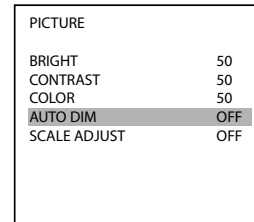

Dim Mode

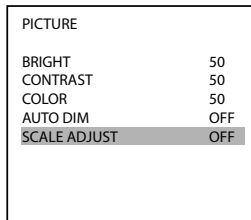

Normal Mode

- Press M to select SCALE ADJUST



Press  to select OFF or  for scale adjustment.

- When the brown wire is connected to the positive wire of back-up light, the distancing grid will be displayed

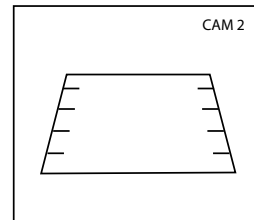



If  is selected, press  to adjust the scale up/down.

2. Option: LANG, SCALE, BLUE BACK, COLOR SYS options will display on the screen as illustrated below.

- Press M to select LANG

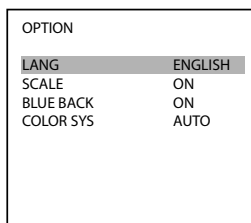
- Press M to select COLOR-SYS



Press  to select English, Deutsch, Français, Español, Português, Italiano, Nederlands or Русский.

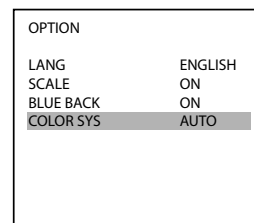

Press  to select AUTO/PAL/NTSC

**Troubleshooting:**

The symptoms described below do not necessarily mean a failure within the display. Please check the following items before you initiate request for repair.

Symptoms	Possible Causes/Solutions
No picture, no sound	Improper connection of automobile adapter. Use of un-authorized power supply. Power switch is on OFF position.
No picture	Check whether AV cable is properly connected
Dark picture	Check whether brightness and contrast are adjusted correctly; Check whether the environments temperature is too low.
No color	Adjust the color settings.
No reversing function (i.e.Picture)	The black wire of the monitor AV cable to the reversing light may be loose. The red wire from the monitor may be loose.

Barriers Phenomena	Reason	Ways to Solve
Image Shaking	Fix-up Bracket Release	Adjust and Stabilize
No Image	Poor connection or system connect cables are broken	CHeck the connection of the monitor to the camera
Image Blurring	Camera lens are dirty	Clean the camera lens
Image Slanting	Cameras not installed in the right way	Adjust the bracket of cameras

Declaration of conformity:



This device complies with Part 15 of the FCC Rules. Operation is subject to the following two conditions:

- (1) This device may not cause harmful interference.
- (2) This device must accept any interference received, including interference that may cause undesired operation.



## **Manufacturer Limited Warranty and Limitation of Liability:**

Manufacturer warrants that on the date of purchase this product will conform to Manufacturer's specifications for this product (which are available from the Manufacturer upon request), and Manufacturer further warrants that this product is free from defects in materials and workmanship. This Limited Warranty extends for 1 year/12 months from the date of purchase. Other warranties may apply, call Manufacturer for details. Manufacturer will, at its discretion, repair or replace any product found by the Manufacturer to be defective and subject to this Limited Warranty.

DAMAGE TO PARTS OR PRODUCTS RESULTING FROM TAMPERING, ACCIDENT, ABUSE, MISUSE, NEGLIGENCE, UNAPPROVED MODIFICATIONS, FIRE OR OTHER HAZARD; IMPROPER INSTALLATION OR OPERATION; OR NOT BEING MAINTAINED IN ACCORDANCE WITH THE MAINTENANCE PROCEDURES SET FORTH IN MANUFACTURER'S INSTALLATION AND OPERATING INSTRUCTIONS VOIDS THIS LIMITED WARRANTY.

ORAL STATEMENTS OR REPRESENTATIONS ABOUT THE PRODUCT WHICH MAY HAVE BEEN MADE BY SALESPEOPLE, DEALERS, AGENTS OR OTHER MANUFACTURER'S REPRESENTATIVES DO NOT CONSTITUTE WARRANTIES. THIS LIMITED WARRANTY MAY NOT BE AMENDED, MODIFIED, OR ENLARGED EXCEPT BY A WRITTEN AGREEMENT SIGNED BY AN AUTHORIZED OFFICIAL OF MANUFACTURER WHICH EXPRESSLY REFERS TO THIS LIMITED WARRANTY.

### **Exclusion of Other Warranties:**

MANUFACTURER MAKES NO OTHER WARRANTIES, EXPRESS OR IMPLIED. THE IMPLIED WARRANTIES FOR MERCHANTABILITY OR FITNESS FOR A PARTICULAR PURPOSE ARE HEREBY EXCLUDED AND SHALL NOT APPLY TO THE PRODUCT. BUYER'S SOLE AND EXCLUSIVE REMEDY IN CONTRACT, TORT, OR UNDER ANY OTHER THEORY AGAINST MANUFACTURER REGARDING THE PRODUCT AND ITS USE SHALL BE THE REPLACEMENT OR REPAIR OF THE PRODUCT AS DESCRIBED ABOVE.

### **Limitation of Liability:**

IN THE EVENT OF LIABILITY FOR DAMAGES ARISING OUT OF THIS LIMITED WARRANTY OR ANY OTHER CLAIM RELATED TO THE MANUFACTURER'S PRODUCTS, MANUFACTURER'S LIABILITY FOR DAMAGES SHALL BE LIMITED TO THE AMOUNT PAID FOR THE PRODUCT AT THE TIME OF THE ORIGINAL PURCHASE. IN NO EVENT SHALL MANUFACTURER BE LIABLE FOR LOST PROFITS, THE COST OF SUBSTITUTE EQUIPMENT OR LABOR, PROPERTY DAMAGE, OR OTHER SPECIAL, CONSEQUENTIAL, OR INCIDENTAL DAMAGES BASED UPON ANY CLAIM FOR BREACH OF CONTRACT, IMPROPER INSTALLATION, NEGLIGENCE, OR OTHER CLAIM, EVEN IF MANUFACTURER OR A MANUFACTURER'S REPRESENTATIVE HAS BEEN ADVISED OF THE POSSIBILITY OF SUCH DAMAGES. MANUFACTURER SHALL HAVE NO FURTHER OBLIGATION OR LIABILITY WITH RESPECT TO THE PRODUCT OR ITS SALE, OPERATION AND USE, AND MANUFACTURER NEITHER ASSUMES NOR AUTHORIZES THE ASSUMPTION OF ANY OTHER OBLIGATION OR LIABILITY IN CONNECTION WITH SUCH PRODUCT.

This Limited Warranty defines specific legal rights. You may have other legal rights which vary from state to state. Some states do not allow the exclusion or limitation of incidental or consequential damages.



10986 North Warson Road  
St. Louis, MO 63114  
Technical Service:  
(314) 996-2800  
cs-c3@code3esg.com  
www.code3esg.com

A Division of ESG | [www.eccogroup.com](http://www.eccogroup.com)